

- Large - Black  
Grand - Noir  
Gross - Schwarz  
Largo - Negro
- Small - White  
Petit - Blanc  
Klein - Weiss  
Pequeño - Blanco
- ⏻ Stand - By  
Attente  
Bereit Stehen  
En Espera
- ⏚ Frame or Chasis  
Masse  
Chassis  
Soporte o Chasis
- ⊕ X-Ray Tube  
Tube Radiogène  
Röntgenröhre  
Tubo de Rayos X
- ⚡ Radiation Filter or Filtration  
Filtre de rayonnement  
Filterung  
Filtración de Radiación

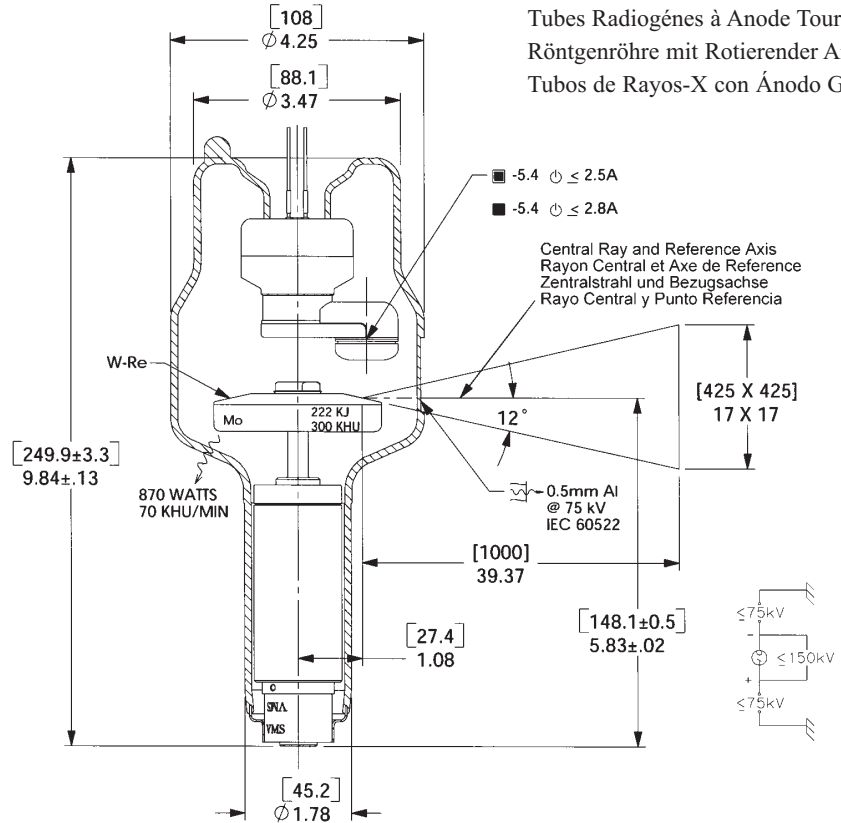

Tubes Radiogènes à Anode Tournante  
 Röntgenröhre mit Rotierender Anode  
 Tubos de Rayos-X con Ánodo Giratorio

Note: Document originally drafted in the English language.

Product Description	Description du Produit	Produktbeschreibung	Descripcion del Producto
<p>The A-134 is a 2.8" (71mm) 150 kV, 222 kJ (300 KHU) maximum anode heat content, rotating anode insert. This insert is specifically designed for heavy duty general radio-graphic and fluoro/spotfilm procedures. The insert features a 12° rhenium-tungsten molybdenum target and is available with the following nominal focal spot:</p> <p style="text-align: center;">0.6 - 1.2 IEC 60336</p> <p><b>Nominal Anode Input Power</b> Small - 32 kW IEC 60613 Large - 76 kW IEC 60613 For the equivalent anode input power of 80 Watts</p> <p>A-134 models have grid control capability.</p>	<p>Le tube A-134, à anode tournante de 71mm, (2,8 pouces), 150 kV, avec une capacité calorifique maximale de 222 kJ (300 kUC) est à usage spécifique pour la radiographie de grande puissance et pour la radio-fluorographie. L'anode composite en Rhénium - Tungstène Molybdène avec pente d'anode de 12° est disponible avec les combinaisons focales suivantes:</p> <p style="text-align: center;">0,6 - 1,2 CEI 60336</p> <p><b>Puissance anodique nominale de l'anode</b> Petit foyer - 32 kW CEI 60613 Grand foyer - 76 kW CEI 60613 Pour la puissance anodique d'équilibre thermique de 80 Watts</p> <p>Les Modèles A-134 ont une fonction de commande de grille.</p>	<p>Die A-134 ist eine 2.8" (71mm) Doppelfokus Drehanoden-Röntgenröhre, mit einer Wärmespeicherkapazität des Anodentellers von 222 kJ (300 KHU) und einer max. Spannungsfestigkeit von 150 kV. Die Röhre wurde für stark frequentierte Aufnahmearbeitsplätze und für den Durchleuchtungs- und Zielgerätebetrieb (1mm FFA) ausgelegt. Der Rhenium, Wolfram, und Molybdän Anodenteller besitzt einen Winkel von 12°. Folgende Brennfleckkombinationen sind lieferbar:</p> <p style="text-align: center;">0.6 - 1.2 IEC 60336</p> <p><b>Nominale Anodenbezugsleistung</b> Klein - 32 kW IEC 60613 Gross - 76 kW IEC 60613 Gilt bei einer Äquivalent - Anodenleistung von 80 Watt</p> <p>Modell A-134 ist mit einer Gittersteuerungsfunktion ausgestattet.</p>	<p>El A-134 es un tubo de ánodo giratorio de 71mm, (2.8"), 150 kV, 222 kJ (300 kUC) diseñado específicamente para procedimientos generales de alto volumen en radiografía y fluoroscopia. Consta de un objetivo de renio, tungsteno y molibdeno con una pendiente de 12 grados. Disponible con las siguientes combinaciones de marcas focales:</p> <p style="text-align: center;">0.6 - 1.2 IEC 60336</p> <p><b>Potencia nominal de entrada del ánodo</b> Foco fine - 32 kW IEC 60613 Foco grueso - 76 kW IEC 60613 Para una potencia equivalente del ánodo de 80 W</p> <p>El Modelo A-134 tiene capacidad para de rejillas controlar los electrones.</p>

Manufactured by Varian Medical Systems  
Fabrique par Varian Medical Systems  
Hergestellt von Varian Medical Systems  
Fabricado por Varian Medical Systems

Specifications subject to change without notice.  
Spécifications susceptibles d'être modifiées sans préavis.  
Technische Daten ohne Gewähr.  
Especificaciones sujetas a cambio sin previo aviso.

### 3 Ø Constant Potential

Abaques de Charge pour Pose Unique CEI 60613  
Brennfleck - Belastungskurven IEC 60613  
Diagramas de Exposición Radiográfica IEC 60613

#### 50 Hz

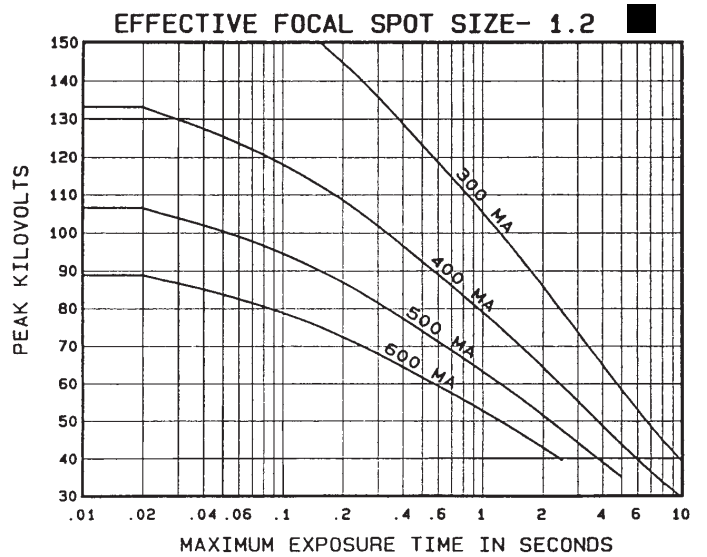
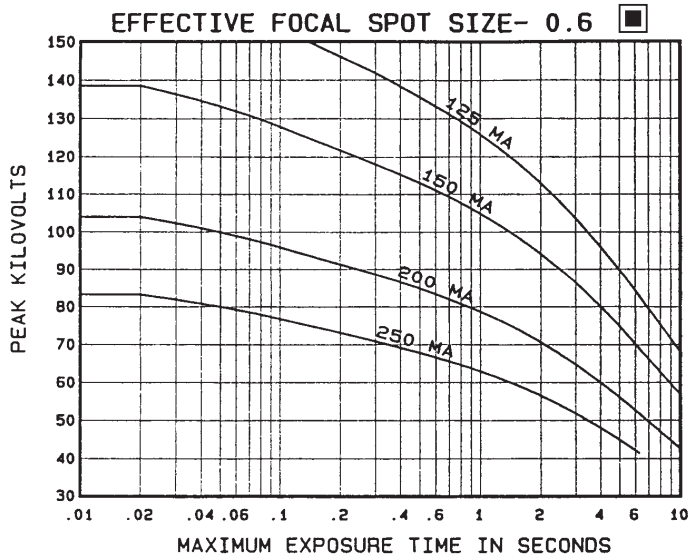

#### 60 Hz

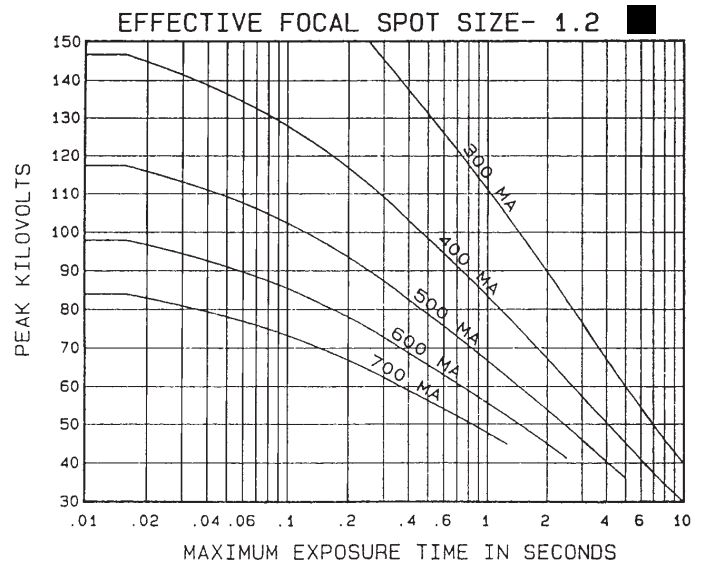
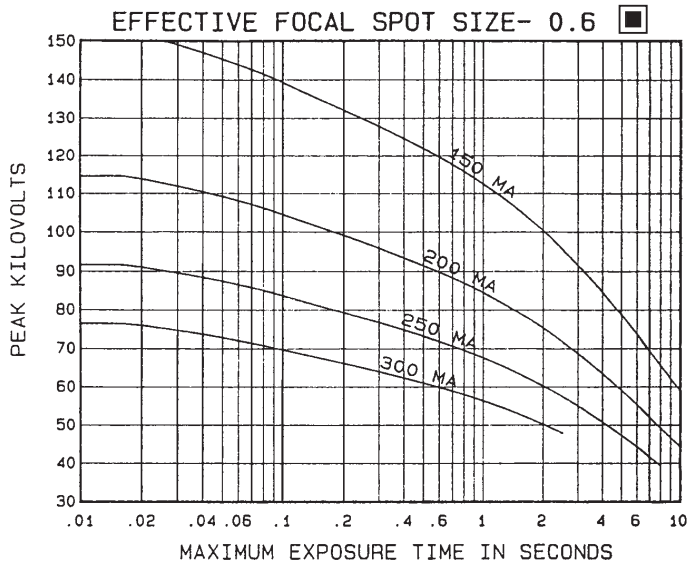

Nominal anode input power for the anode heat content 40%. IEC 60613

Puissance calorifique nominale de l'anode: 40%, CEI 60613

Thermische Anodenbezugsleistung bei einer Wärmespeicherung von 40%. IEC 60613

Aproximadamente el poder de penetración para obtener un almacenaje de calor del anodo de 40%. IEC 60613

### 3 Ø Constant Potential

Abaques de Charge pour Pose Unique CEI 60613  
Brennfleck - Belastungskurven IEC 60613  
Diagramas de Exposición Radiográfica IEC 60613

## 150 Hz

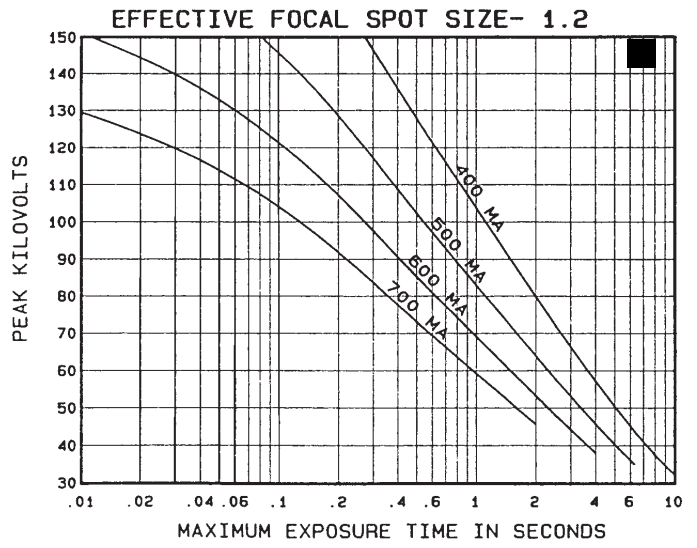
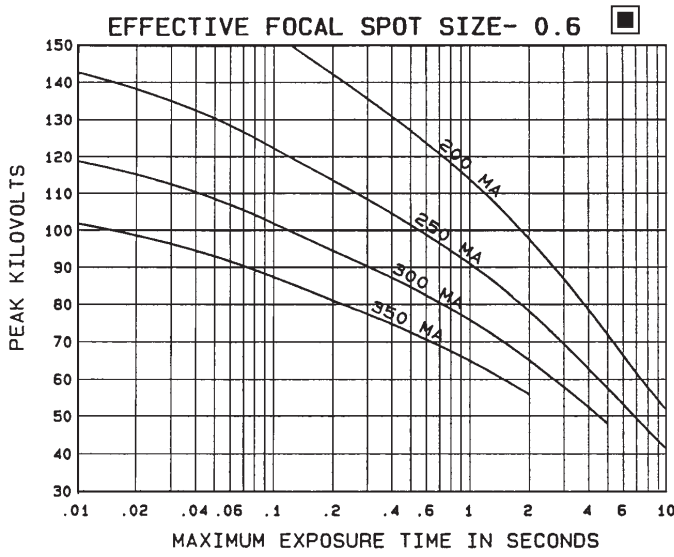

## 180 Hz

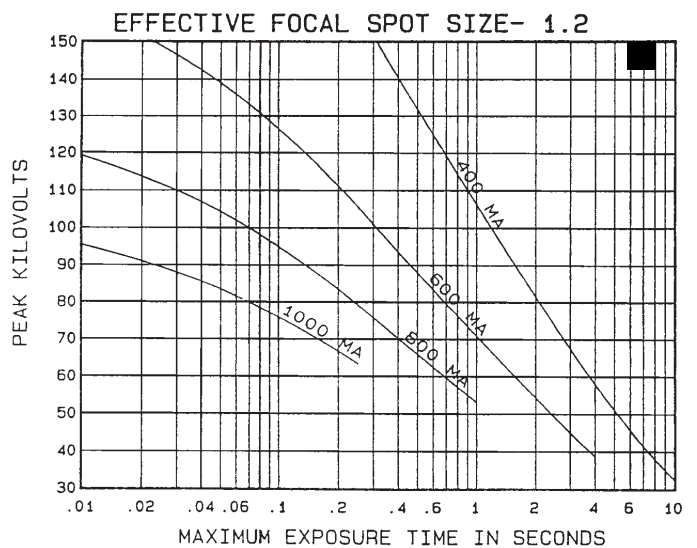
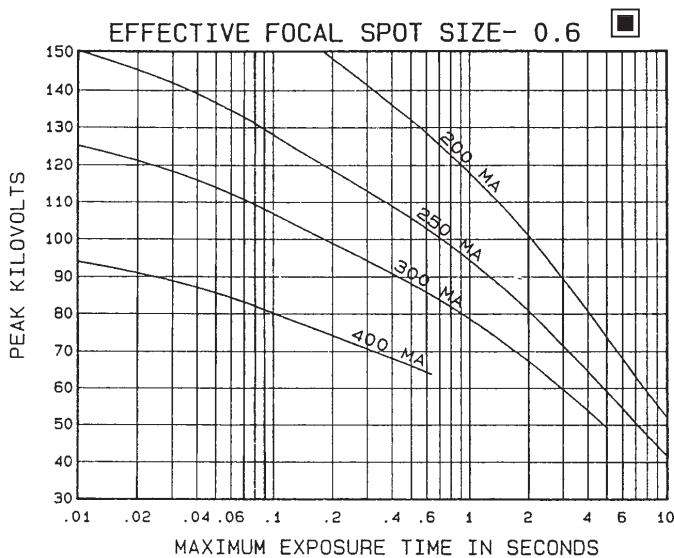

Nominal anode input power for the anode heat content 40%. IEC 60613

Puissance calorifique nominale de l'anode: 40%, CEI 60613

Thermische Anodenbezugsleistung bei einer Wärmespeicherung von 40%. IEC 60613

Aproximadamente el poder de penetración para obtener un almacenaje de calor del anodo de 40%. IEC 60613

## ANGIOGRAPHIC RATINGS

### HOW TO USE ANGIOGRAPHIC CHARTS

**General:** Serial Radiography puts a severe demand on the x-ray tube due to the large number of exposures made in rapid succession. Intervals between exposures are fixed and so short that it is not possible for the anode track to cool to any extent during the exposure series. Therefore, the temperature of the anode track increases from exposure to exposure. The kW values used in the angiographic charts have been determined to prevent damage to the anode. The angiographic rating charts are usable to 100% anode heat storage. Exceeding 100% anode heat storage will cause anode track erosion with high risk of tube destruction.

#### Definition of Terms

**Number of Exposures in Series:** The number of exposures made in succession or the number of exposures made during one contrast injection.

**Exposure Rate:** The number of exposures made per second. For a series of exposures where the exposure rate changes, it must be assumed that all exposures will be made at the maximum rate. For example, if during a series 10 exposures will occur at one per second and 30 exposures at 4 per second use the kW ratings in the 40 exposure column at 4 per second rate.

**Exposure Time:** Time in seconds of each exposure.

#### USING THE CHARTS:

**Determine the number of exposures in Series:** With cut film angiography the number of exposures are known, however in Digital Angiography the number of exposures commonly are not known. When determining the number of exposures, assume worst case or past history.

**Note:** Most angiographic x-ray tubes fail from underestimating the number of exposures made in a series.

**Determine kW of each exposure in Series:** Referring to chart —find block under “Number of Exposures in Series” that is greater than or equal to expected number of exposures in Series. On left side directly opposite this block under “Exposure Rate per Second” column, select maximum rate per second that will be used for the exposure series. At the intersection of exposure rate and exposure time in seconds, find maximum kW allowed for each exposure.

**kW = pkV x mA:** The kW of the exposure can be any combination of mA and pkV allowed by the Radiographic and Filament Emission charts.

For Example: 80 pkV and 500 mA = 40 kW

**Example:** From chart A-134 150/180 Hz 3 Phase 1.2 Focal Spot, determine kW allowed with following known factors.  
Maximum number of exposures .....40  
Exposure time .050 second (50 milliseconds)  
Maximum Exposures per second .....4

From chart find 40 exposure block. On left side directly opposite this block under “Exposure Rate per Second” column, select 4 exposures per second. Find .050 seconds at top of chart. At intersection of exposure rate line and exposure time, find 43.5 kW.

0.6 Focal Spot 3Ø 12 Degrees 150/180 Hz  
0.6 Brennpunkt 3Ø 12 Grad 150/180 Hz  
0.6 Dimension Focale 3Ø 12 Degrés 150/180 Hz  
0.6 De Marcas Focales 3Ø 12 Grados 150/180 Hz

Caractéristiques Pour L'Angiographie CEI 60613  
Angiographische Nennleistungen IEC 60613  
Gradaciones Angiografica IEC 60613

EXPOSURE RATE PER SECOND	TUBE LOAD (KW) AS A FUNCTION OF THE EXPOSURE TIME (SEC.) OF THE INDIVIDUAL RADIOGRAPHS OF THE SERIES															NUMBER OF EXPOSURES IN SERIES
	.010	.020	.030	.040	.050	.060	.080	.100	.120	.140	.160	.180	.200	.225	.250	
1	29.5	28.1	27.0	26.1	25.3	24.6	23.3	22.2	21.2	20.4	19.7	19.0	18.4	17.7	17.1	20
2	29.4	27.9	26.7	25.8	24.9	24.1	22.8	21.6	20.6	19.7	19.0	18.3	17.6	16.9	16.3	
3	29.3	27.7	26.5	25.4	24.5	23.7	22.3	21.1	20.0	19.1	18.3	17.6	0.0	0.0	0.0	
4	29.2	27.5	26.2	25.1	24.2	23.3	21.8	20.5	19.4	18.5	0.0	0.0	0.0	0.0	0.0	
8	28.8	26.8	25.3	24.0	22.8	21.8	0.0	0.0	0.0	0.0	0.0	0.0	0.0	0.0	0.0	
15	28.2	25.8	23.7	22.2	0.0	0.0	0.0	0.0	0.0	0.0	0.0	0.0	0.0	0.0	0.0	
30	27.1	24.1	0.0	0.0	0.0	0.0	0.0	0.0	0.0	0.0	0.0	0.0	0.0	0.0	0.0	
1	29.0	27.2	25.8	24.6	23.5	22.6	21.0	19.6	18.5	17.5	16.6	15.3	13.8	12.2	11.0	40
2	28.9	27.0	25.5	24.2	23.1	22.2	20.5	19.1	17.9	16.9	16.0	15.2	13.8	12.2	11.0	
3	28.7	26.8	25.2	23.9	22.7	21.7	20.0	18.6	17.4	16.3	15.4	14.6	0.0	0.0	0.0	
4	28.6	26.5	24.9	23.6	22.4	21.3	19.6	18.1	16.8	15.8	0.0	0.0	0.0	0.0	0.0	
8	28.2	25.8	23.9	22.3	21.0	19.9	0.0	0.0	0.0	0.0	0.0	0.0	0.0	0.0	0.0	
15	27.5	24.6	22.3	20.5	0.0	0.0	0.0	0.0	0.0	0.0	0.0	0.0	0.0	0.0	0.0	
30	26.2	22.7	0.0	0.0	0.0	0.0	0.0	0.0	0.0	0.0	0.0	0.0	0.0	0.0	0.0	
1	28.5	26.3	24.6	23.2	22.0	20.9	19.1	17.6	15.3	13.1	11.5	10.2	9.2	8.1	7.3	60
2	28.4	26.1	24.4	22.9	21.6	20.5	18.7	17.1	15.3	13.1	11.5	10.2	9.2	8.1	7.3	
3	28.2	25.9	24.1	22.6	21.3	20.1	18.2	16.7	15.3	13.1	11.5	10.2	0.0	0.0	0.0	
4	28.1	25.7	23.8	22.3	20.9	19.8	17.8	16.3	15.0	13.1	0.0	0.0	0.0	0.0	0.0	
8	27.6	24.9	22.8	21.1	19.6	18.4	0.0	0.0	0.0	0.0	0.0	0.0	0.0	0.0	0.0	
15	26.9	23.7	21.2	19.3	0.0	0.0	0.0	0.0	0.0	0.0	0.0	0.0	0.0	0.0	0.0	
30	25.6	21.8	0.0	0.0	0.0	0.0	0.0	0.0	0.0	0.0	0.0	0.0	0.0	0.0	0.0	
1	28.0	25.6	23.6	22.1	20.7	19.5	17.2	13.8	11.5	9.8	8.6	7.6	6.9	6.1	5.5	80
2	27.9	25.3	23.4	21.7	20.3	19.1	17.2	13.8	11.5	9.8	8.6	7.6	6.9	6.1	5.5	
3	27.8	25.1	23.1	21.4	20.0	18.8	16.8	13.8	11.5	9.8	8.6	7.6	0.0	0.0	0.0	
4	27.6	24.9	22.8	21.1	19.7	18.4	16.4	13.8	11.5	9.8	0.0	0.0	0.0	0.0	0.0	
8	27.1	24.1	21.8	20.0	18.5	17.2	0.0	0.0	0.0	0.0	0.0	0.0	0.0	0.0	0.0	
15	26.4	23.0	20.3	18.3	0.0	0.0	0.0	0.0	0.0	0.0	0.0	0.0	0.0	0.0	0.0	
30	25.0	21.0	0.0	0.0	0.0	0.0	0.0	0.0	0.0	0.0	0.0	0.0	0.0	0.0	0.0	
1	27.6	24.8	22.7	21.0	19.5	18.3	13.8	11.0	9.2	7.9	6.9	6.1	5.5	4.9	4.4	100
2	27.5	24.6	22.4	20.7	19.2	17.9	13.8	11.0	9.2	7.9	6.9	6.1	5.5	4.9	4.4	
3	27.3	24.4	22.2	20.4	18.9	17.6	13.8	11.0	9.2	7.9	6.9	6.1	0.0	0.0	0.0	
4	27.2	24.2	21.9	20.1	18.6	17.3	13.8	11.0	9.2	7.9	0.0	0.0	0.0	0.0	0.0	
8	26.7	23.4	21.0	19.0	17.4	16.1	0.0	0.0	0.0	0.0	0.0	0.0	0.0	0.0	0.0	
15	25.9	22.3	19.5	17.4	0.0	0.0	0.0	0.0	0.0	0.0	0.0	0.0	0.0	0.0	0.0	
30	24.6	20.3	0.0	0.0	0.0	0.0	0.0	0.0	0.0	0.0	0.0	0.0	0.0	0.0	0.0	
1	26.5	23.2	20.7	18.3	14.7	12.2	9.2	7.3	6.1	5.2	4.6	4.1	3.7	3.3	2.9	150
2	26.4	23.0	20.5	18.3	14.7	12.2	9.2	7.3	6.1	5.2	4.6	4.1	3.7	3.3	2.9	
3	26.3	22.8	20.2	18.2	14.7	12.2	9.2	7.3	6.1	5.2	4.6	4.1	0.0	0.0	0.0	
4	26.1	22.6	20.0	18.0	14.7	12.2	9.2	7.3	6.1	5.2	0.0	0.0	0.0	0.0	0.0	
8	25.6	21.8	19.1	17.0	14.7	12.2	0.0	0.0	0.0	0.0	0.0	0.0	0.0	0.0	0.0	
15	24.9	20.8	17.8	15.6	0.0	0.0	0.0	0.0	0.0	0.0	0.0	0.0	0.0	0.0	0.0	
30	23.5	18.9	0.0	0.0	0.0	0.0	0.0	0.0	0.0	0.0	0.0	0.0	0.0	0.0	0.0	
1	23.8	18.3	12.2	9.2	7.3	6.1	4.6	3.7	3.1	2.6	2.3	2.0	1.8	1.6	1.5	300
2	23.7	18.3	12.2	9.2	7.3	6.1	4.6	3.7	3.1	2.6	2.3	2.0	1.8	1.6	1.5	
3	23.6	18.3	12.2	9.2	7.3	6.1	4.6	3.7	3.1	2.6	2.3	2.0	0.0	0.0	0.0	
4	23.5	18.3	12.2	9.2	7.3	6.1	4.6	3.7	3.1	2.6	0.0	0.0	0.0	0.0	0.0	
8	23.0	18.3	12.2	9.2	7.3	6.1	0.0	0.0	0.0	0.0	0.0	0.0	0.0	0.0	0.0	
15	22.3	17.4	12.2	9.2	0.0	0.0	0.0	0.0	0.0	0.0	0.0	0.0	0.0	0.0	0.0	
30	21.1	15.9	0.0	0.0	0.0	0.0	0.0	0.0	0.0	0.0	0.0	0.0	0.0	0.0	0.0	

**Note:**  
1. (kW) of Exposure Equals mA x kV.  
For Example: 70 kV x 300 mA = 21 kW.  
2. Exposures less than .010 seconds will have a kW rating same as .010 seconds.

**Remarque:**  
1. (kW) en exposition égale kV x mA.  
Par exemple: 70 kV x 300 mA = 21 kW.  
2. Les expositions inférieures à 0.010 sec. ont les mêmes valeurs en kW que celles de 0.010 sec.

**Anmerkungen:**  
1. (kW) der Belichtung is gleich mA x kV  
Zum Beispiel: 70 kV x 300 mA = 21 kW.  
2. Belichtungen von weniger als .010 Sekunden haben die gleichen kW Werte wie die von .010 Sekunden.

**Nota:**  
1. (kW) De exposición se calcula multiplicando mA x kV-por ejemplo: 70 kV x 300 mA = 21 kW.  
2. Para exposición de menos de .010 segundos, el resultado en (kW) seria lo mismo que el de .010 segundos.

Nominal anode input power for the anode heat content 70%. IEC 60613

Puissance calorifique nominale de l'anode: 70%, CEI 60613

Thermische Anodenbezugsleistung bei einer Wärmespeicherung von 70%. IEC 60613

Aproximadamente el poder de penetracion para obtener un almacenaje de calor del anode de 70%. IEC 60613

1.2 Focal Spot 3Ø 12 Degrees 150/180 Hz  
1.2 Brennpunkt 3Ø 12 Grad 150/180 Hz  
1.2 Dimension Focale 3Ø 12 Degrés 150/180 Hz  
1.2 De Marcas Focales 3Ø 12 Grados 150/180 Hz

Caractéristiques Pour L'Angiographie CEI 60613  
Angiographische Nennleistungen IEC 60613  
Gradaciones Angiografica IEC 60613

EXPOSURE RATE PER SECOND	TUBE LOAD (KW) AS A FUNCTION OF THE EXPOSURE TIME (SEC.) OF THE INDIVIDUAL RADIOGRAPHS OF THE SERIES															NUMBER OF EXPOSURES IN SERIES
	.010	.020	.030	.040	.050	.060	.080	.100	.120	.140	.160	.180	.200	.225	.250	
1	72.9	66.9	62.4	58.7	55.5	52.7	48.1	44.3	41.2	38.5	34.4	30.6	27.5	24.4	22.0	20
2	72.2	65.8	61.0	57.0	53.7	50.8	46.0	42.1	38.8	36.1	33.8	30.6	27.5	24.4	22.0	
3	71.6	64.8	59.7	55.5	52.0	49.0	44.0	40.0	36.8	34.0	31.7	29.7	0.0	0.0	0.0	
4	71.1	64.0	58.7	54.4	50.8	47.7	42.2	38.2	34.9	32.2	0.0	0.0	0.0	0.0	0.0	
8	69.3	61.2	55.1	50.4	46.5	43.2	0.0	0.0	0.0	0.0	0.0	0.0	0.0	0.0	0.0	
15	66.9	57.5	50.7	45.6	0.0	0.0	0.0	0.0	0.0	0.0	0.0	0.0	0.0	0.0	0.0	
30	63.3	52.4	0.0	0.0	0.0	0.0	0.0	0.0	0.0	0.0	0.0	0.0	0.0	0.0	0.0	
1	69.9	62.0	56.1	51.5	47.7	44.4	34.4	27.5	22.9	19.6	17.2	15.3	13.8	12.2	11.0	40
2	69.2	60.9	54.8	50.0	46.1	42.8	34.4	27.5	22.9	19.6	17.2	15.3	13.8	12.2	11.0	
3	68.5	59.8	53.5	48.6	44.6	41.2	34.4	27.5	22.9	19.6	17.2	15.3	0.0	0.0	0.0	
4	67.9	59.0	52.6	47.6	43.5	40.1	34.4	27.5	22.9	19.6	0.0	0.0	0.0	0.0	0.0	
8	65.9	56.0	49.0	43.7	39.5	36.1	0.0	0.0	0.0	0.0	0.0	0.0	0.0	0.0	0.0	
15	63.0	52.0	44.5	39.0	0.0	0.0	0.0	0.0	0.0	0.0	0.0	0.0	0.0	0.0	0.0	
30	58.6	46.2	0.0	0.0	0.0	0.0	0.0	0.0	0.0	0.0	0.0	0.0	0.0	0.0	0.0	
1	67.1	57.8	51.1	45.8	36.7	30.6	22.9	18.3	15.3	13.1	11.5	10.2	9.2	8.1	7.3	60
2	66.4	56.8	49.9	44.7	36.7	30.6	22.9	18.3	15.3	13.1	11.5	10.2	9.2	8.1	7.3	
3	65.7	55.8	48.8	43.5	36.7	30.6	22.9	18.3	15.3	13.1	11.5	10.2	0.0	0.0	0.0	
4	65.2	55.0	47.9	42.5	36.7	30.6	22.9	18.3	15.3	13.1	0.0	0.0	0.0	0.0	0.0	
8	63.1	52.0	44.6	39.1	34.9	30.6	0.0	0.0	0.0	0.0	0.0	0.0	0.0	0.0	0.0	
15	60.1	48.1	40.4	34.8	0.0	0.0	0.0	0.0	0.0	0.0	0.0	0.0	0.0	0.0	0.0	
30	55.4	42.4	0.0	0.0	0.0	0.0	0.0	0.0	0.0	0.0	0.0	0.0	0.0	0.0	0.0	
1	64.6	54.2	45.8	34.4	27.5	22.9	17.2	13.8	11.5	9.8	8.6	7.6	6.9	6.1	5.5	80
2	63.9	53.2	45.8	34.4	27.5	22.9	17.2	13.8	11.5	9.8	8.6	7.6	6.9	6.1	5.5	
3	63.3	52.3	44.9	34.4	27.5	22.9	17.2	13.8	11.5	9.8	8.6	7.6	0.0	0.0	0.0	
4	62.7	51.5	44.0	34.4	27.5	22.9	17.2	13.8	11.5	9.8	0.0	0.0	0.0	0.0	0.0	
8	60.6	48.8	41.0	34.4	27.5	22.9	0.0	0.0	0.0	0.0	0.0	0.0	0.0	0.0	0.0	
15	57.6	45.0	37.2	31.7	0.0	0.0	0.0	0.0	0.0	0.0	0.0	0.0	0.0	0.0	0.0	
30	52.9	39.5	0.0	0.0	0.0	0.0	0.0	0.0	0.0	0.0	0.0	0.0	0.0	0.0	0.0	
1	62.3	51.0	36.7	27.5	22.0	18.3	13.8	11.0	9.2	7.9	6.9	6.1	5.5	4.9	4.4	100
2	61.6	50.1	36.7	27.5	22.0	18.3	13.8	11.0	9.2	7.9	6.9	6.1	5.5	4.9	4.4	
3	61.0	49.2	36.7	27.5	22.0	18.3	13.8	11.0	9.2	7.9	6.9	6.1	0.0	0.0	0.0	
4	60.4	48.6	36.7	27.5	22.0	18.3	13.8	11.0	9.2	7.9	0.0	0.0	0.0	0.0	0.0	
8	58.4	46.0	36.7	27.5	22.0	18.3	0.0	0.0	0.0	0.0	0.0	0.0	0.0	0.0	0.0	
15	55.5	42.4	34.5	27.5	0.0	0.0	0.0	0.0	0.0	0.0	0.0	0.0	0.0	0.0	0.0	
30	50.8	37.2	0.0	0.0	0.0	0.0	0.0	0.0	0.0	0.0	0.0	0.0	0.0	0.0	0.0	
1	57.2	36.7	24.4	18.3	14.7	12.2	9.2	7.3	6.1	5.2	4.6	4.1	3.7	3.3	2.9	150
2	56.6	36.7	24.4	18.3	14.7	12.2	9.2	7.3	6.1	5.2	4.6	4.1	3.7	3.3	2.9	
3	56.0	36.7	24.4	18.3	14.7	12.2	9.2	7.3	6.1	5.2	4.6	4.1	0.0	0.0	0.0	
4	55.5	36.7	24.4	18.3	14.7	12.2	9.2	7.3	6.1	5.2	0.0	0.0	0.0	0.0	0.0	
8	53.6	36.7	24.4	18.3	14.7	12.2	0.0	0.0	0.0	0.0	0.0	0.0	0.0	0.0	0.0	
15	50.9	36.7	24.4	18.3	0.0	0.0	0.0	0.0	0.0	0.0	0.0	0.0	0.0	0.0	0.0	
30	46.5	32.8	0.0	0.0	0.0	0.0	0.0	0.0	0.0	0.0	0.0	0.0	0.0	0.0	0.0	
1	36.7	18.3	12.2	9.2	7.3	6.1	4.6	3.7	3.1	2.6	2.3	2.0	1.8	1.6	1.5	300
2	36.7	18.3	12.2	9.2	7.3	6.1	4.6	3.7	3.1	2.6	2.3	2.0	1.8	1.6	1.5	
3	36.7	18.3	12.2	9.2	7.3	6.1	4.6	3.7	3.1	2.6	2.3	2.0	0.0	0.0	0.0	
4	36.7	18.3	12.2	9.2	7.3	6.1	4.6	3.7	3.1	2.6	0.0	0.0	0.0	0.0	0.0	
8	36.7	18.3	12.2	9.2	7.3	6.1	0.0	0.0	0.0	0.0	0.0	0.0	0.0	0.0	0.0	
15	36.7	18.3	12.2	9.2	0.0	0.0	0.0	0.0	0.0	0.0	0.0	0.0	0.0	0.0	0.0	
30	36.7	18.3	0.0	0.0	0.0	0.0	0.0	0.0	0.0	0.0	0.0	0.0	0.0	0.0	0.0	

**Note:**  
1. (kW) of Exposure Equals mA x kV.  
For Example: 70 kV x 300 mA = 21 kW.  
2. Exposures less than .010 seconds will have a kW rating same as .010 seconds.

**Remarque:**  
1. (kW) en exposition égale kV x mA.  
Par exemple: 70 kV x 300 mA = 21 kW.  
2. Les expositions inférieures à 0.010 sec. ont les mêmes valeurs en kW que celles de 0.010 sec.

**Anmerkungen:**  
1. (kW) der Belichtung is gleich mA x kV  
Zum Beispiel: 70 kV x 300 mA = 21 kW.  
2. Belichtungen von weniger als .010 Sekunden haben die gleichen kW Werte wie die von .010 Sekunden.

**Nota:**  
1. (kW) De exposición se calcula multiplicando mA x kV-por ejemplo: 70 kV x 300 mA = 21 kW.  
2. Para exposición de menos de .010 segundos, el resultado en (kW) seria lo mismo que el de .010 segundos.

Nominal anode input power for the anode heat content 70%. IEC 60613

Puissance calorifique nominale de l'anode: 70%, CEI 60613

Thermische Anodenbezugsleistung bei einer Wärmespeicherung von 70%. IEC 60613

Aproximadamente el poder de penetracion para obtener un almacenaje de calor del anode de 70%. IEC 60613

**3 Ø FULL WAVE**

Abaques d'Émissions des Filaments CEI 60613  
Glühfadenemissionsdiagramm IEC 60613  
Curvas de Emisión de los Filamentos IEC 60613

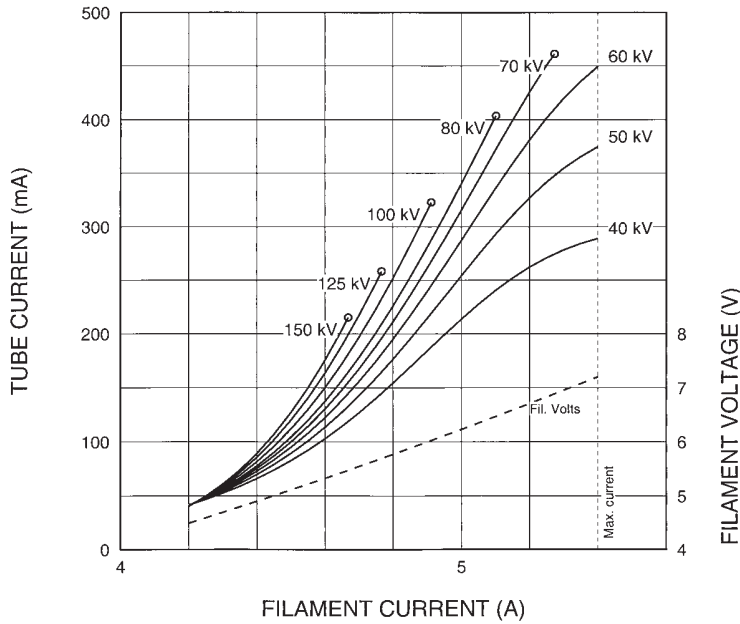

THREE PHASE EMISSION ( $\pm .15$  A)  
A-134      0.6     

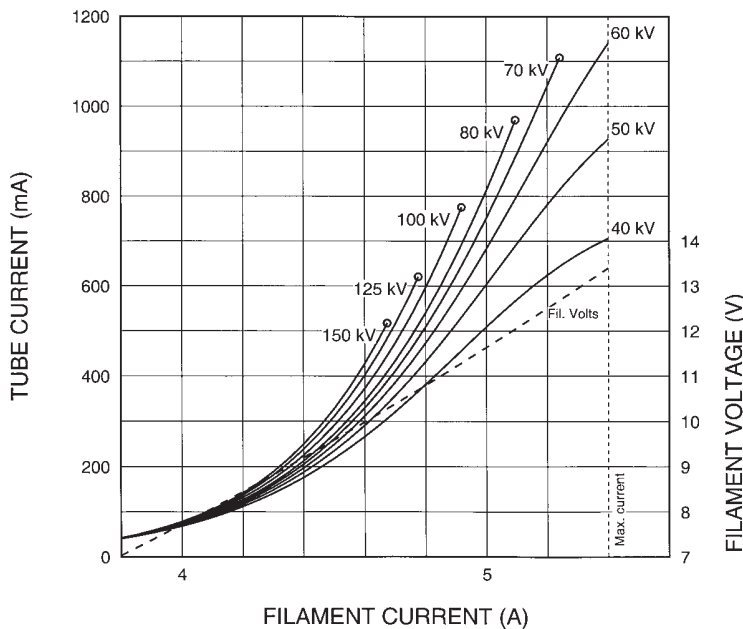

THREE PHASE EMISSION ( $\pm .15$  A)  
A-134      1.2     

Note:	When using these emission curves for trial exposures, refer to the power rating curves shown for maximum kV, tube emission, filament current, exposure time, and target speed.
Remarque:	Lors de l'utilisation de ces abaques pour des expositions d'essai, référez-vous aux courbes maximales de kV, d'émission du filament, de temps d'exposition et de vitesse de rotation.
Anmerkung:	Wenn Sie diese Emissionskurven für Testaufnahmen verwenden, beziehen Sie sich hierbei auf die entsprechenden Nennleistungskurven für max. kV-Werte, Röhrenemission, Heizstrom, und Anodendrehzahl.
Nota:	Si utiliza estas curvas de emisión para exposiciones de prueba, refiérase a las curvas de gradación de potencia para el máximo de kV, tubo de emisión, corriente en los filamentos, tiempo de exposición, y a las curvas de velocidad del objetivo.

Abaques d'Échauffement et de Refroidissement de L'Anode  
Anodenerhitzungs und Kühlungsdiagramm  
Curvas de Calentamiento y Enfriamiento del Anodo

